

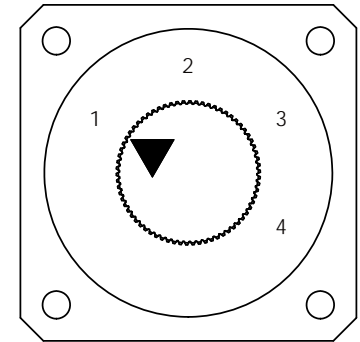

Coaxial Switch - L□C14KMT SP4T, SMA, Manual

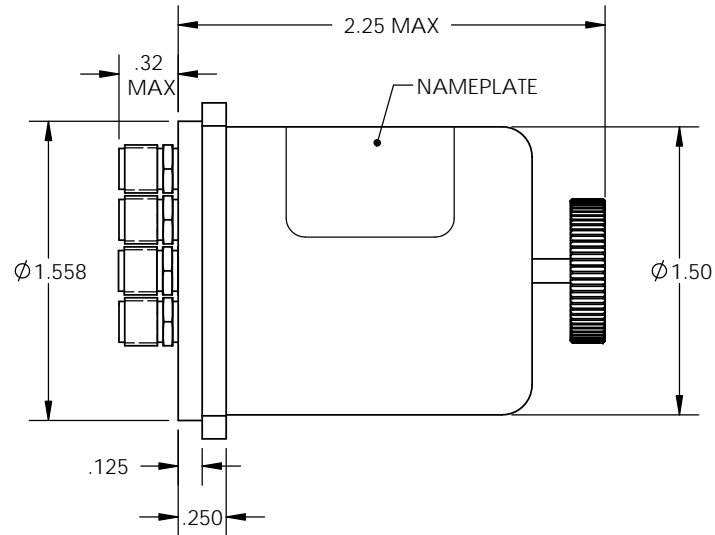
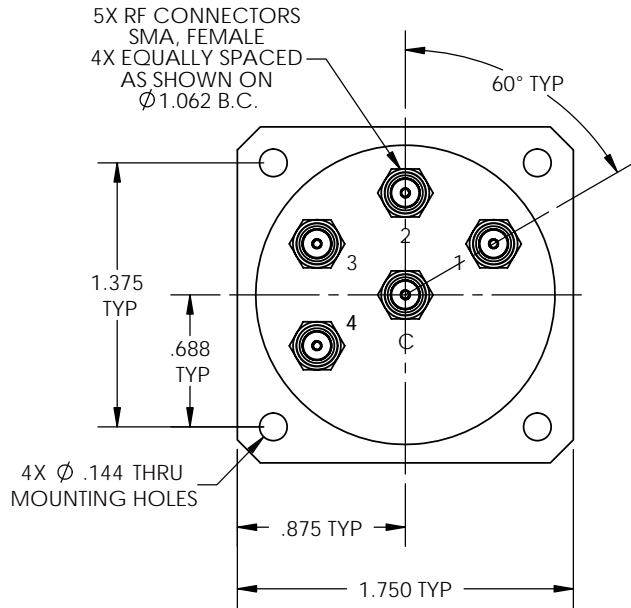

Frequency (GHz)	DC to 3	3 to 8	8 to 12.4	12.4 to 18
VSWR (max.)	1.2:1	1.3:1	1.4:1	1.5:1
Insertion Loss (max.)	0.2 dB	0.3 dB	0.4 dB	0.5 dB
Isolation (min.)	80 dB	70 dB	60 dB	60 dB
Power (max.)	100 WCW	75 WCW	60 WCW	45 WCW

RF Impedance: 50 ohms
 Material: Aluminum (RF Assy)
 RF Contacts: Break Before Make
 Finish: Iridite per MIL-DTL-5541, Type II Class 3
 Cover Black

STYLE	ENVIRONMENT	OPERATING TEMPERATURE	NON-OPERATING TEMPERATURE	HUMIDITY
LM	SHELTERED	0°C to +70°C	-40°C to +100°C	0 to 95%
LW	OUTDOOR	-40°C to +85°C	-55°C to +100°C	0 to 100%

RoHS Compliant